

High-Precision Motion Solutions Made for Industry

PI Is Your Partner for Increasing Your Output

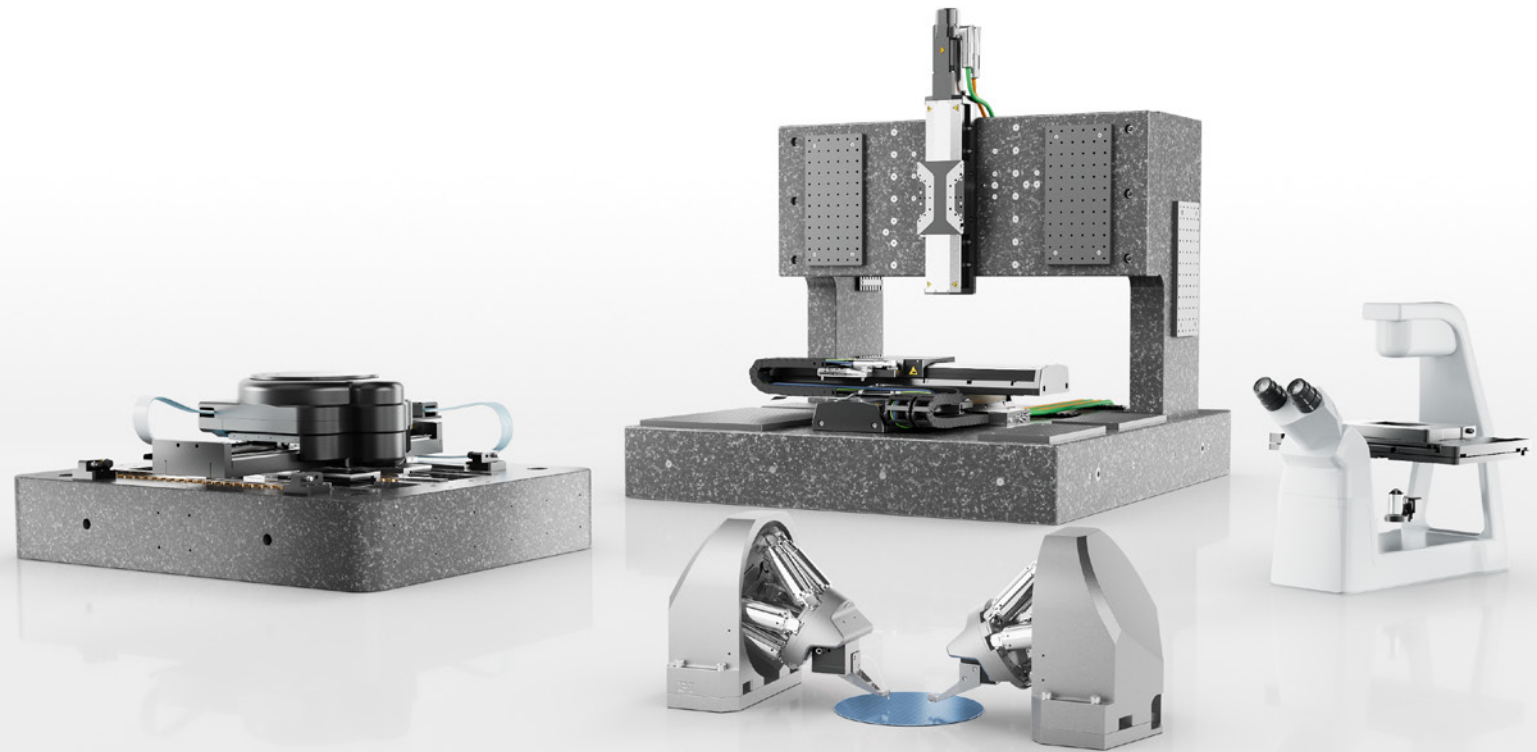

Enabling Precision Across Industries

From Cutting-Edge Prototype Design to Efficient Serial Production

Leading industries around the world rely on trusted technology partners to drive progress and innovation. PI stands out as a global supplier, delivering high-precision motion solutions that meet the most demanding customer expectations.

From cutting-edge prototyping to efficient serial production, we partner with leading industries and research institutes in the following markets: Semiconductor, Industrial Automation, and Photonics, as well as Microscopy & Life Sciences. For more than fifty years, we have been playing a pivotal role in opening new markets, driving innovation, and pushing boundaries together with our customers.

These achievements are founded on our competencies in nanopositioning, performance automation, and piezo technology, as well as a unique technology portfolio, a continuous innovation pipeline, and a deep understanding of our customers' applications.

As markets evolve at an ever-increasing pace, accompanied by rising demands for scalability, flexibility, and cost-effectiveness alongside technological challenges, we continuously adapt our business and operating modes to support our customers' growth strategies. In recent years, we have significantly expanded our capacities, resources, and production capabilities around the globe to scale efficiently and to provide our customers with regional access to leading motion solutions.

We are committed to pushing boundaries together with our customers and making high-precision motion technology available on an industrial scale, enabling our customers to stay at the forefront of their markets.



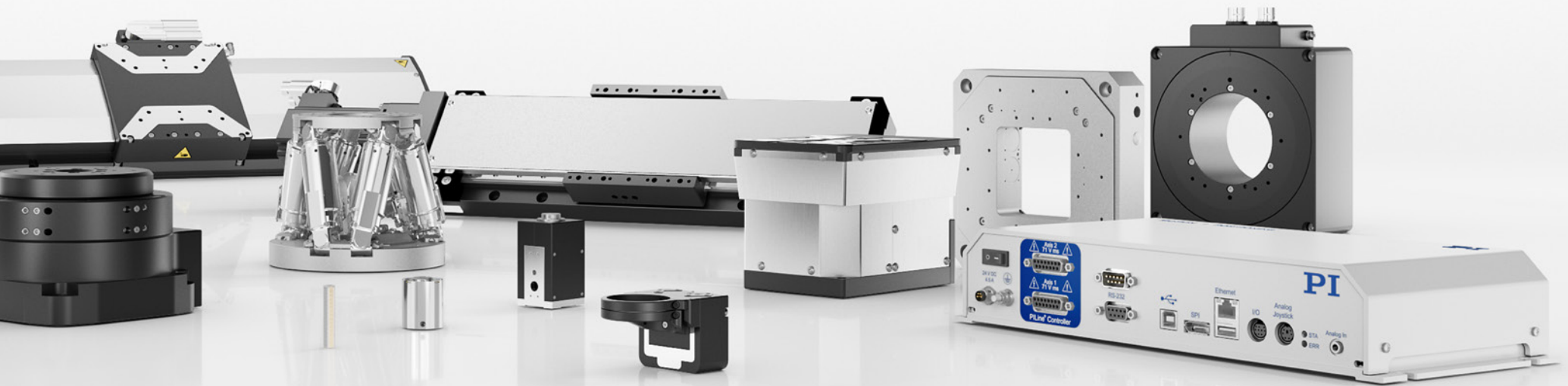

PHOTONICS

Industry-Leading Solutions for Fast and Reliable Alignment

Test, Assembly, and Packaging of Photonic Devices

Proven 6DoF Hexapod and Piezo Systems for Array Alignment

Key Features

- Simultaneous active alignment across multiple array channels, I/Os, elements, and degrees of freedom
- Parallel processing for 100 times the speed of serial operation
- 99 % reduction in alignment-time cost
- Scalable for fab-class operation
- Reliable tracking during long-term process steps
- Optimization of any figure of merit

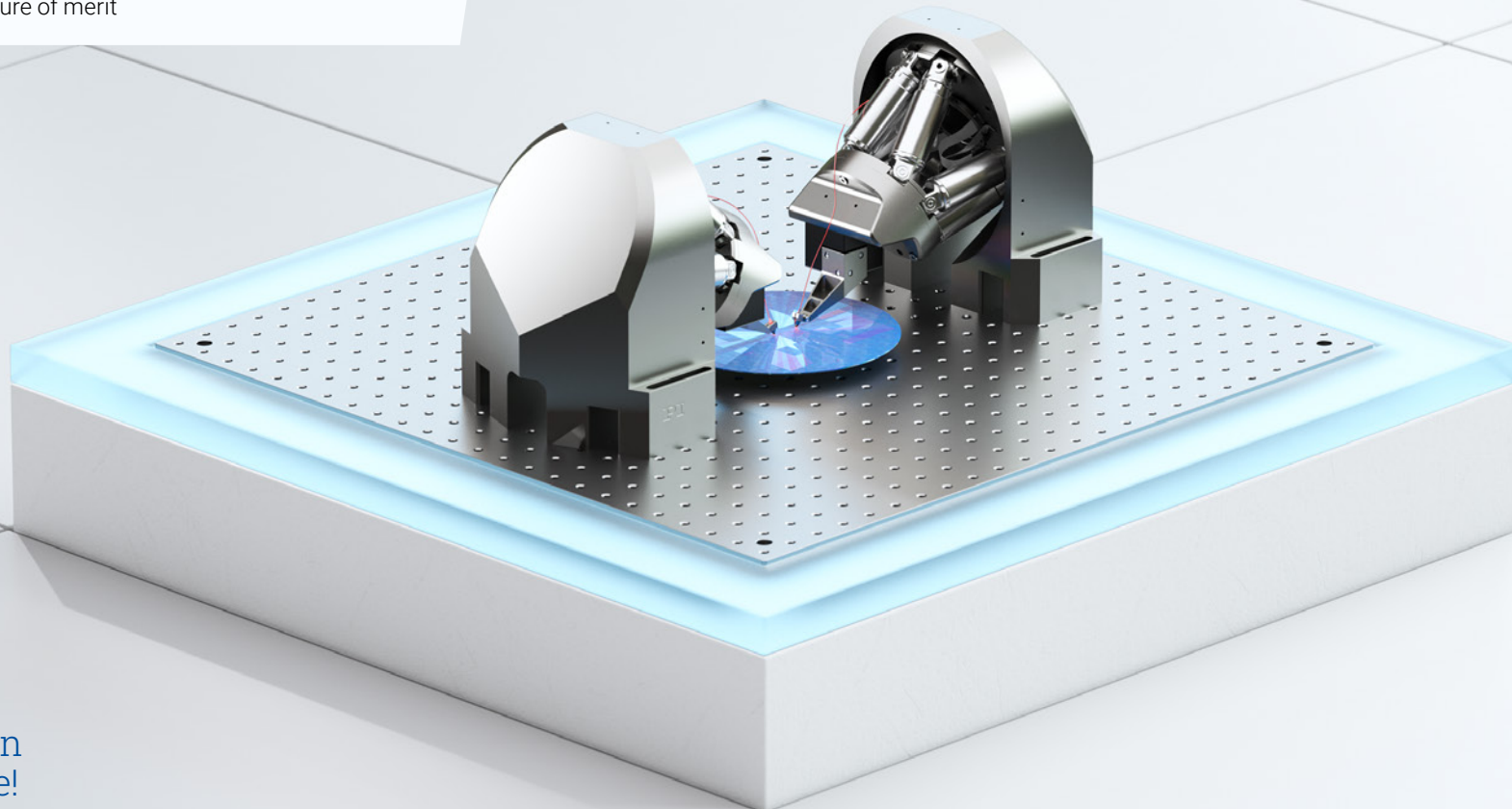

Learn
more!

Integrating photonic structures or elements such as waveguides, photodiodes, lasers, and multiplexers presents a variety of demanding challenges to test and assembly processes, starting at wafer level through to final packaging. The common theme: multiple channels, multiple elements, and multiple interacting inputs, as well as outputs, across multiple degrees of freedom, all requiring multiple alignment optimization. Traditionally, this is a time-consuming and expensive task. PI's Multi-Channel Photonics Alignment (FMPA) systems and unique proprietary alignment algorithms, which are built into the controller, automatically enable simultaneous alignment across channels, devices, and degrees of freedom, optimizing overall alignment in one quick step. Subsequently, compared to serial operation, reduction of 99 % in time and costs is possible.

XYZ Axis: Nanometer Alignment of Optical Components

- Parallel-kinematic piezo system for high stiffness in all spatial orientations
- Mechanical design provides scanning frequencies of up to 100 Hz, as well as fast tracking
- Zero-play flexure guides for high guiding accuracy without any wear or particle generation
- Integrated sensors offer excellent linearity of motion and long-term stability
- Piezo actuators with all-ceramic insulation for an outstanding lifetime

>> **P-616 NanoCube® Nanopositioner**

>> **F-712 Double-Sided Alignment System**

XYZ / θX θY θZ : Submicron Alignment of Optical Components

- Parallel-kinematic hexapod for alignment in six degrees of freedom
- High stiffness of the mechanical design provides high dynamics and short settling times
- Freely-definable center of rotation allows flexible alignment
- Position sensors ensure high accuracy and operational reliability
- Compact design for space-saving integration

>> **H-811 6-Axis Miniature Hexapod**

>> **F-712 Double-Sided Alignment System**

User-Friendly and Flexible Automation Control

- EtherCAT® interfaces for fast integration into high-throughput industrial systems
- High-performance industrial controllers with built-in scan and alignment routines automate and optimize in parallel with millisecond responsiveness
- Proprietary firmware enables fast alignment based on fast area-scanning algorithms for first light detection and gradient search for peak coupling
- Software support for common operating systems, as well as for many programming languages including MATLAB, Python, C#, and NI LabVIEW
- Quick start-up and ease-of-use thanks to PIMicroMove software

>> **C-887 Hexapod Motion Controller with EtherCAT®**

>> **E-712 Digital Piezo Controller**

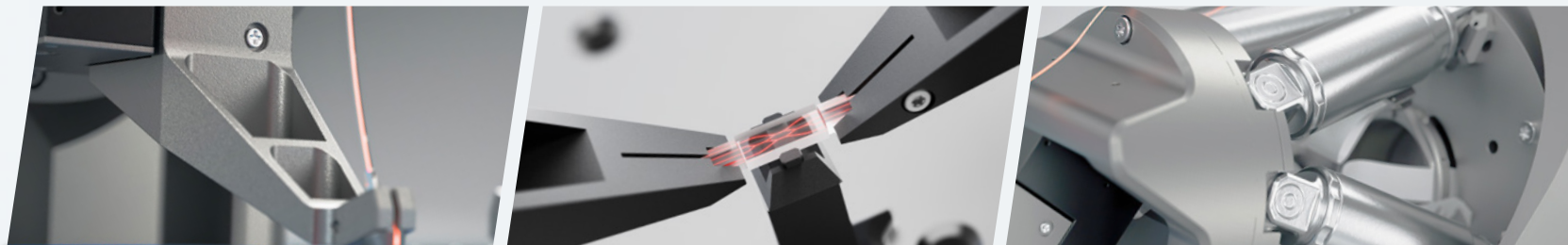

Testing and Probing for Mass Production

Cost-Optimized Fast Alignment Solutions for High-Volume Production of PICs

Key Features

- Compact and modular 4DoF or 6DoF design
- Flexible configurations: from simple XY setups to full six degrees of freedom
- Lightning-fast alignment algorithms for cutting-edge testing
- Fast data acquisition and ultra-low noise measurements
- Patent-pending alignment technology for accelerated processing

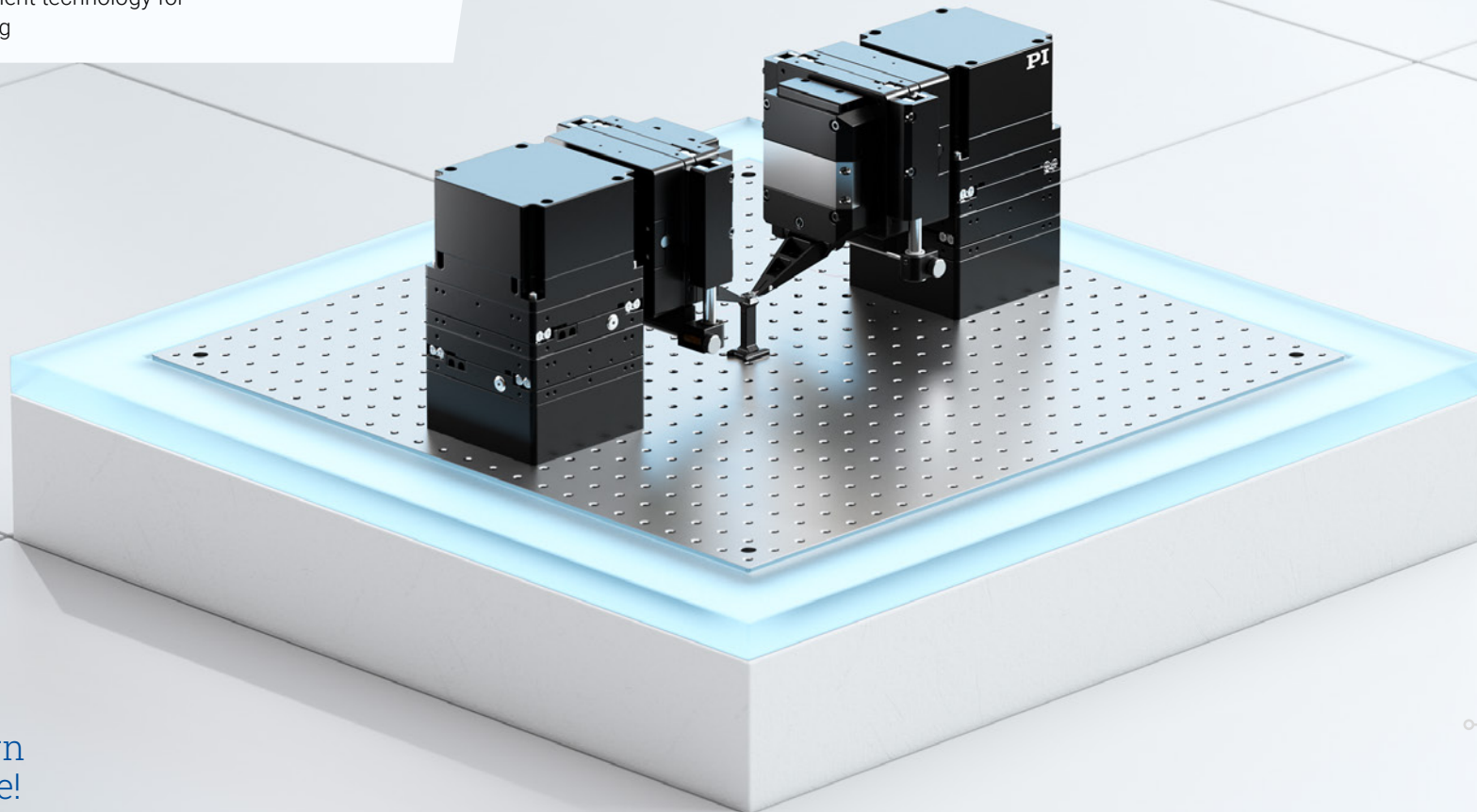

Learn
more!

Silicon photonics is a cornerstone of breakthrough advances such as data processing, communications, artificial intelligence, and quantum computing. As global demand for silicon photonics integrated circuits surges, high-volume manufacturing has become vital to support this rapid growth. PI's cutting-edge technologies offer unparalleled precision, speed, and reliability in probing and testing applications, ensuring production-ready performance at scale. Being purpose-engineered solutions with a focus on automation and throughput optimization, PI's systems are tailored to meet the exacting requirements of modern silicon photonics integrated circuit fabrication. These advanced systems empower manufacturers to achieve unmatched efficiency, consistency, and excellence in their processes.

θZ Axis: Precise Rotational Positioning of Photonic Devices

- Innovative flexure design featuring direct drive motor technology
- Purpose-engineered for highly dynamic, short stroke, repetitive motion sequences used in advanced photonics alignment
- Optimized moving platform for convenient mounting with minimal lever arm for direct optical probing
- High-resolution incremental linear encoder with low CTE scales

XYZ Axis: Fiber-to-Fiber and Fiber-to-Waveguide Alignment

- Compact integrated XYZ version featuring direct drive motor technology for high dynamics and fast step-and-settle
- Compact geometry using ultra-precision crossed roller bearings with minimized angular amplified errors for highly repeatable positioning at the probe tip
- Adjustable magnetic counterbalance enabling vertical operation with minimal impact on form factor
- High-resolution incremental linear encoders with low CTE scales for repeatable and accurate positioning

>> **Direct Drive Linear Motor Stages**

θY and θZ Axis: Fine Angular Fiber Positioning During Setup

- Ultra-fine automated angular adjustments (θY and θZ) for extended travel of $\pm 4^\circ$ with microradian precision
- Stepper motor technology for the highest stiffness on pitch and yaw axes while XYZ movement and rotation around the optical axis are highly dynamic
- Easy access to the PIC or wafer with reduced applied moment load
- Innovative design with improved resonant characteristics, enhancing system stability and first-mode resonance performance

Motion Control

- Flexible expandable controller platform
- IP-protected onboard algorithms with easy functioning
- Advanced EtherCAT® control system with optimized master processor providing rapid signal analysis for onboard machine learning
- Fast, synchronous data processing of multi-axis position and analog voltage signals
- Real-time execution and algorithmic computation
- Ultra-low noise drives with high-resolution analog inputs (24 bits)

>> **A-81x PIGlide Motion Controller**



Alignment of Optical Fibers and Photonic Devices

Cost-Effective Alignment Solutions

Key Features

- Affordable photonics alignment systems
- Modular design for easy adaptability and upgradeability
- Advanced EtherCAT® Control System and a computationally optimized master processor for rapid signal analysis

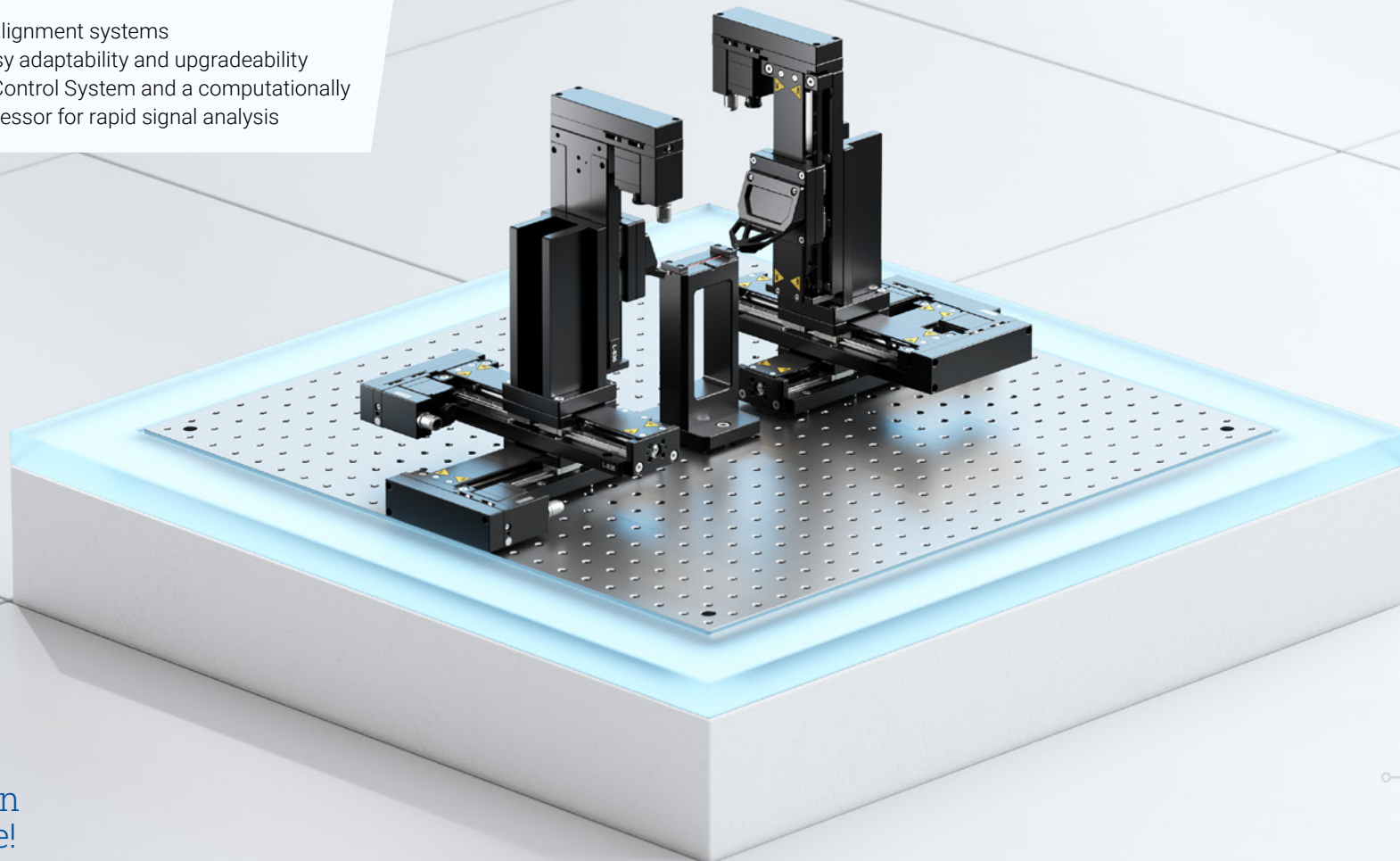

Learn
more!

Photonics, the science and application of light, has transformed industries ranging from telecommunications and healthcare to manufacturing and beyond. With the increasing demand for high-speed data communication, processing, and advanced sensing technologies, photonics has become integral to innovation. Silicon photonics, in particular, has surged, combining optics with semiconductor technology for unprecedented performance and energy efficiency. As the global reliance on photonics grows, the industry demands new solutions for testing and assembly. PI provides high-end alignment systems for applications where throughput is key, as well as affordable alignment engines based on modular precision positioning stages. Both ends of the spectrum benefit from PI's high-performance motion controllers with award-winning embedded alignment algorithms.

XYZ Axis: Precision Linear Stages

- Low profile, compact, high-stiffness mechanical design
- Travel ranges up to 200 mm
- Precision ball screw and recirculating ball bearing guides
- Direct drive stepper motors, 40 mm/s max. velocity
- Linear encoder option for higher accuracy and repeatability
- Holding brake option to prevent collisions
- Economically priced with fast delivery

>> **L-836 Universal Linear Stage**

Optional Rotary Stages

- Highly accurate and repeatable rotation
- Choice of direct drive and worm-gear designs
- Closed-loop option for higher accuracy and repeatability

>> **Rotary Stages**

High Performance Motion Controller

- EtherCAT® controller for open network connectivity
- Embedded high-performance alignment algorithms for fast and reliable alignment

>> **Motion Controller**



Lightning-Fast Alignment Algorithms

Eliminating the Top Cost Driver for Photonics Device Manufacturing

One of the critical challenges in scaling to meet the new demands of the Photonics industry is the precise alignment of optical components — a task that has traditionally been time-consuming, labor-intensive, and subject to multiple repetitions in the test and assembly process. Recognizing alignment as the top cost driver in photonic device manufacturing, PI has made it a primary focus area. By performing optimization in parallel across multiple channels, components, and degrees of freedom and by achieving coupling repeatabilities to typically 0.02 dB, our Fast Multichannel Photonics Alignment (FMPA) systems reduce time and costs for the manufacturing and testing of photonic devices and improve yield. Before the optimization process can even start, however, an optical signal above the noise level must be detectable. First light detection is particularly time-consuming in devices with inputs and outputs where both sides must be lined up for even a threshold amount of coupling to be achieved.

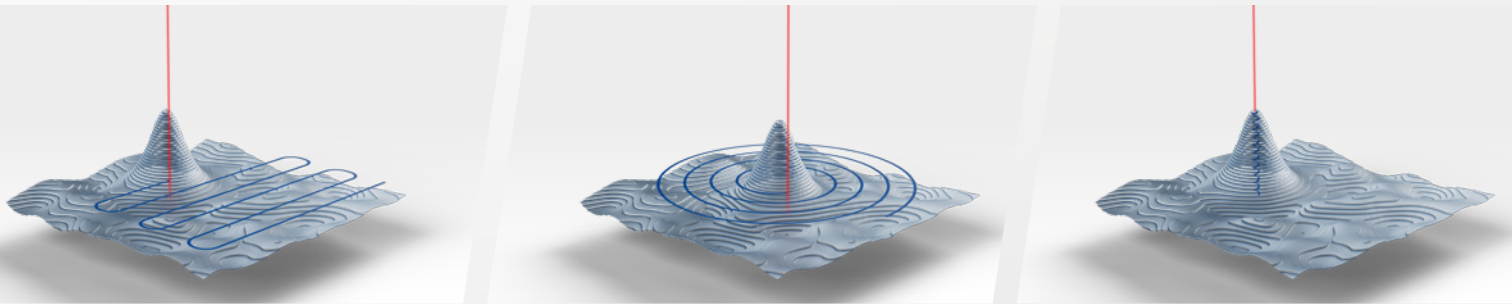

Finding first light using current signal search methods is based on area scans followed by gradient search or layered optimization. Performing spiral scans or sinusoidal raster scans at a micron-to-submicron scale, however, can require significant time to complete depending on the area that must be searched, whether inputs and outputs need to be simultaneously aligned, and so on.

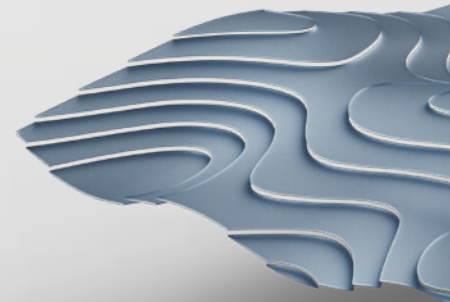

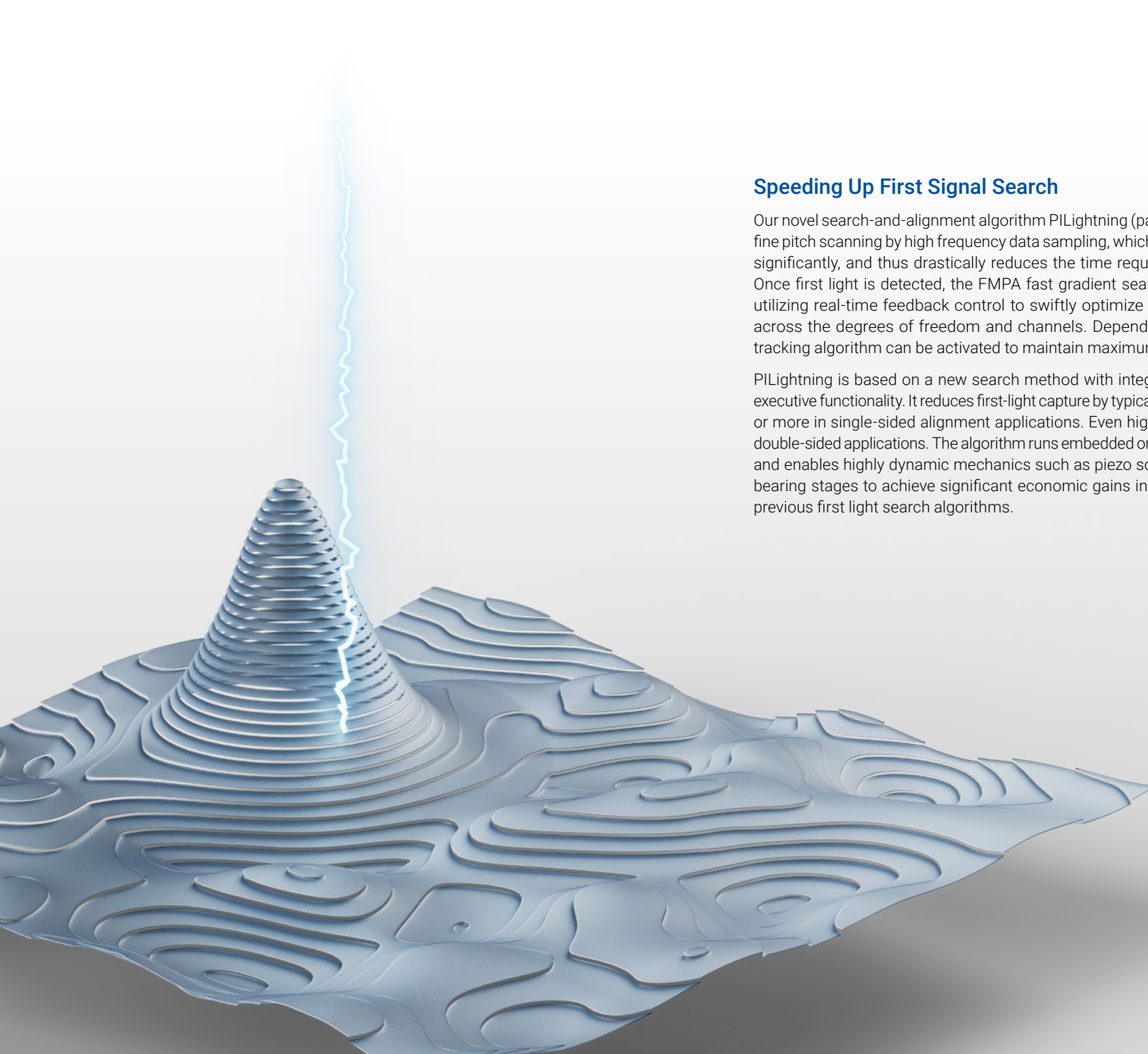

Speeding Up First Signal Search

Our novel search-and-alignment algorithm PLightning (patent applied for) replaces fine pitch scanning by high frequency data sampling, which raises alignment speeds significantly, and thus drastically reduces the time required to acquire first light. Once first light is detected, the FMPA fast gradient search algorithm takes over, utilizing real-time feedback control to swiftly optimize the alignment in parallel across the degrees of freedom and channels. Depending on the application, a tracking algorithm can be activated to maintain maximum coupling efficiency.

PLightning is based on a new search method with integrated AI-based real-time executive functionality. It reduces first-light capture by typically one order of magnitude or more in single-sided alignment applications. Even higher gains are achieved in double-sided applications. The algorithm runs embedded on PI's advanced controllers and enables highly dynamic mechanics such as piezo scanners or direct drive air bearing stages to achieve significant economic gains in production compared to previous first light search algorithms.



Learn more in our whitepaper!



Free Space Optical Communication

Fast Steering Mirrors for Laser Beam Control

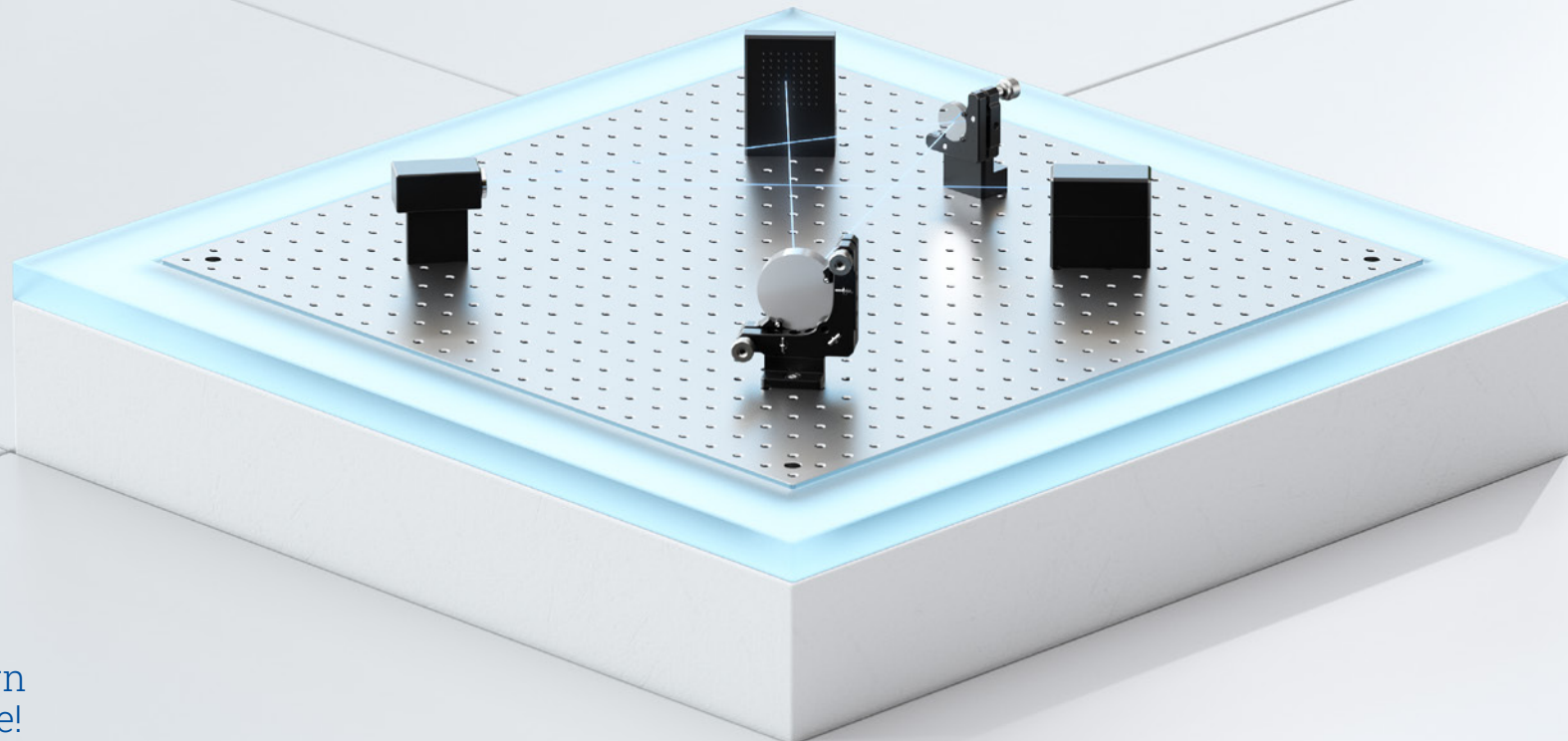

Learn
more!

As an alternative to fiber optic cables, several technology companies are working on deploying extensive low earth orbit space-based communications networks. Compact satellites acting as their nodes are launched into orbit, utilizing laser light to connect to each other, and efficiently transmit data across the globe. On Earth, a comparable method of establishing secure point-to-point networks even in densely populated areas is emerging through the use of “fiberless photonics.”

Piezoelectric or electromagnetic Fast Steering Mirrors (FSM) from PI provide angular resolution down to the nanorad scale with a mechanical bandwidth reaching up to the kHz range. These mirrors effectively compensate for common disturbances in various applications. While piezo-driven FSMs offer a higher resolution and bandwidth, electromagnetic units (usually voice coil FSMs) allow larger displacements. PI's solutions are based on the ability to scale up quickly to large quantities and on the adaptation of standardized tip/tilt systems to meet specific customer needs.

Fast Piezo Steering Mirror Platform

- Tip/tilt angle up to 5 mrad, optical deflection angle up to 10 mrad
- Differential drive for increased stability
- Two orthogonal tip/tilt axes with common center of rotation
- High resonant frequencies to 10 kHz (0.5" mirror) for dynamic motion and fast step-and-settle
- Parallel kinematics design provides identical high dynamics of both axes
- Ultra-compact design
- Durable and friction-free thanks to flexures
- Sensors for high linearity in closed-loop operation
- For mirrors up to Ø 12.7 mm (0.5")
- Mars-rover tested PICMA[®] piezo actuators and flexure guides

>> **S-331 High-Speed Tip/Tilt Platform**

Fast Voice Coil Steering Mirror Platform

- Tip/tilt angle up to 4°, optical deflection angle up to 8°
- Differential drive for increased stability
- Two orthogonal tip/tilt axes with common center of rotation
- Parallel-kinematic design providing identical high dynamics of both axes
- Compact design
- Durable and friction-free thanks to flexures
- Optical encoders for high precision closed-loop operation
- Custom designs for space applications

>> **V-931 High Dynamics PIMag[®] Voice Coil Tip/Tilt Platform**

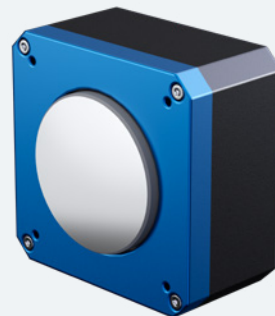
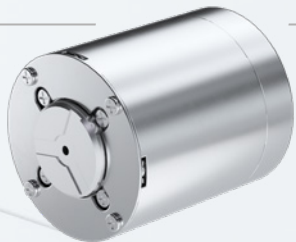

SEMICONDUCTOR

Motion and Positioning Solutions for High-Throughput Manufacturing

Wafer Inspection and Metrology

Highly Dynamic and Precise Piezo Wafer Positioning Solutions

Key Features

- Defect and edge placement error (EPE) inspections
- Highly adaptive surface inspection
- High throughput
- Reduced dynamic errors and optimized focusing time
- High reliability at high duty cycles

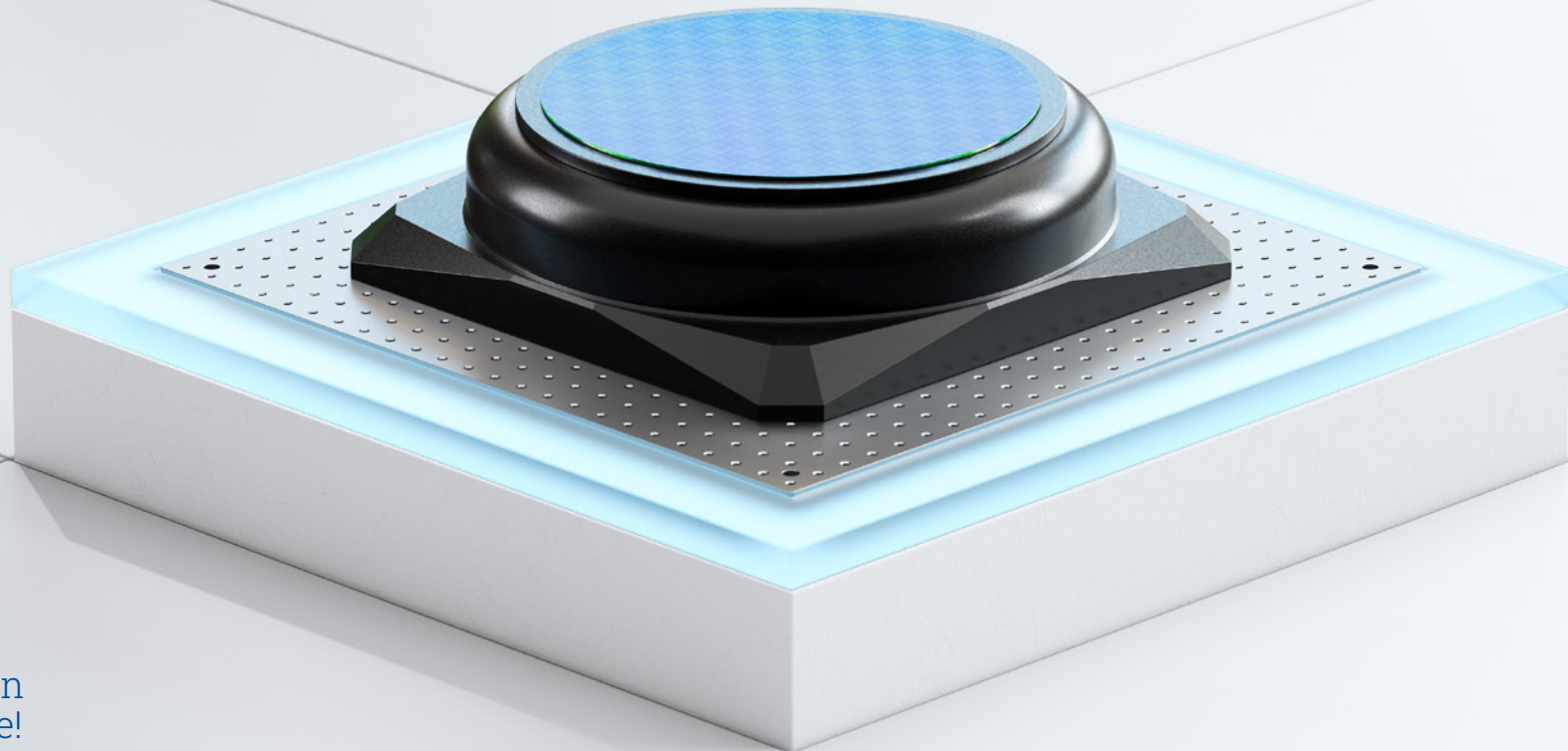

Learn
more!

Efficient wafer inspection and metrology are essential in semiconductor manufacturing to prevent yield loss. Achieving this requires precise wafer positioning, which enables fast and reliable analysis of defects and particles at every production stage.

PI's cutting-edge piezo wafer positioning solution outperforms traditional electromagnetic systems with its innovative design, advanced control capabilities, and seamless connectivity. Featuring a dual-function piezo actuator, hybrid kinematics, and next-gen motion controller, the system delivers unmatched precision and reliability. The solution corrects wafer misalignment, maintains precise positioning, and eliminates heat generation by operating energy-free in a static state. Dynamic piezo adjustments ensure flatness and angular error compensation, guaranteeing consistent focus accuracy.

Z Axis: Dynamic Tracking

- Piezo motor technology
- Power off holding ability
- High resonant frequency enables highly dynamic tracking and correction mode for fine motion.
- Travel range: up to 4 mm coarse and 50 μm fine
- Move-and-settle time <10 ms (0.01 μm - 50 μm)
- Bidirectional repeatability: 10 nm (1 sigma)
- Position stability <5 nm

θ Z Axis: High-Accuracy Motion

- Piezo motor technology
- High resonance frequency for highest stability
- Travel range: up to ± 6 mrad for highest accuracy, can be extended to up to 360°
- Move-and-settle time <20 ms (0.1 μrad - 100 μrad)
- Bidirectional repeatability: 0.5 μrad (1 sigma)
- Position stability <0.05 μrad

Tip/Tilt Axis: High Stability

- Piezo motor technology
- High resonance frequency for highest stability
- Travel range: up to ± 2 mrad
- Move-and-settle time <10 ms (0.1 μrad - 150 μrad)
- Bidirectional repeatability 0.5 μrad (1 sigma)
- Position stability <0.05 μrad

Liftpin Function: Integrated Wafer Lift

- DC motor driven spindle
- Travel range >10 mm
- Velocity: up to 20 mm/s
- Bidirectional repeatability <1 μm (1 sigma)



Film Metrology in Wafer Inspection

Granite-Based Motion Systems for Cost-Effective Scanning and Location of Defects

Key Features

- Repeatable and fast step-and-settle motion
- Reliable and high quality for mass production
- ISO 14644 cleanroom class 5 compatibility
- Advanced ACS control features: gantry control, 2D mapping
- Global design and metrology standards

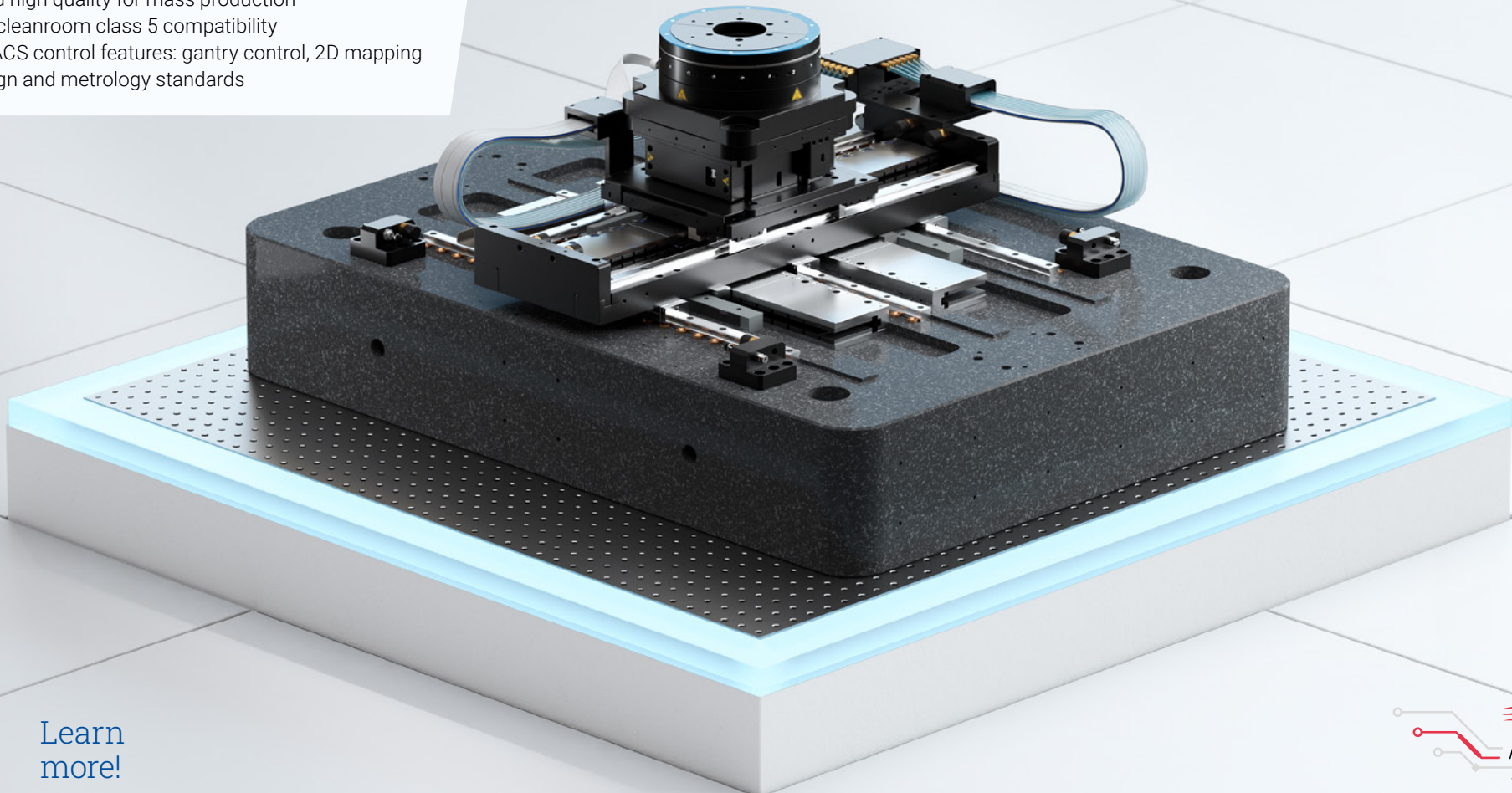

Learn
more!

For every type of wafer, key prerequisites include uniform substrate and device layer thickness, along with a minimal defect density. Moreover, the wafer's electrical resistivity must closely align with specified standards. Certain films necessitate characterization, especially for assessing thickness, electrical resistivity, and surface quality and roughness. Reliable and fast measurement technologies help to prevent yield losses by detecting defects in an early stage, and thereby reducing costs.

PI is currently developing motion solutions for wafer positioning to facilitate the measurement of crucial wafer attributes.

θZ Axis: Fine Rotary Indexing and Alignment of Wafer or Substrate

- Highly accurate and repeatable 360° rotation without backlash
- High velocities and accelerations due to magnetic direct drives
- Direct-drive, slotless, brushless torque motor offers very low cogging torques and enables smooth speed and low error motions
- Ultra-precise air bearings developed and manufactured in house
- Next level performance to further optimize asynchronous performance specifications

>> **Technology of Direct Drive Torque Motors**

Z Axis: Precision Wafer Alignment

- Low profile, high load, compact superior design
- Direct drive voice coil technology provides zero cogging, smooth motion with nanometer step size and response
- High-resolution encoder for nanometer positioning of the motion platform
- High-precision anti-creep crossed-roller bearings
- Pneumatic counter balance prevents motor heating and avoids collisions
- Economically priced with fast delivery

>> **Technology of Direct Drive Motors**

XY Axis: Precision Step-and-Settle Motion

- High-dynamics, coupled ironless linear motors on base axes for powerful, fast and precise motion
- Dual encoder system ensures motor and yaw alignment, while providing high resolution and accuracy
- Multiple bearing stiff platform with low profile reduces abbe offsets and offers increased flatness and straightness
- Design allows high flexibility and customization
- Optimized integrated cable management reduces motion drag and prolongs lifetime
- Granite base ensures highest performance of the motion system
- Optional active isolation

>> **Direct Drive Linear Motor Stages**

Flexible and Easy Automation Control

- EtherCAT® controller for open network connectivity
- Advanced algorithms provide fast step-and-settle, high in-position stability, and exceptional constant scanning velocity >> **ServoBoost™**
- Autofocus capabilities of the controller for dynamic focus adjustment
- Look-ahead capability adjusts velocity to maintain accuracy

>> **Motion Controller**

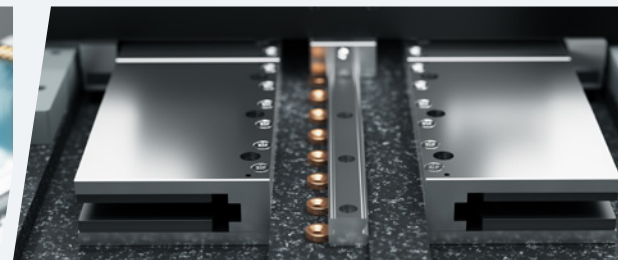
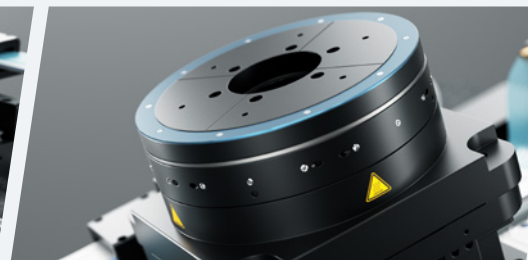
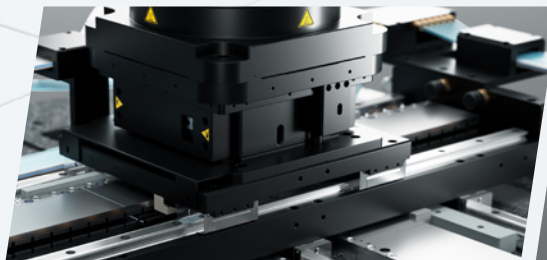

Wafer Stealth Dicing

Motion Solutions Enabling Chip Singulation with High Throughput and Precision

Key Features

- High-yield, high-throughput chip singulation
- No wear and tear system, requiring minimum maintenance
- Contamination free
- Synchronized advanced laser control

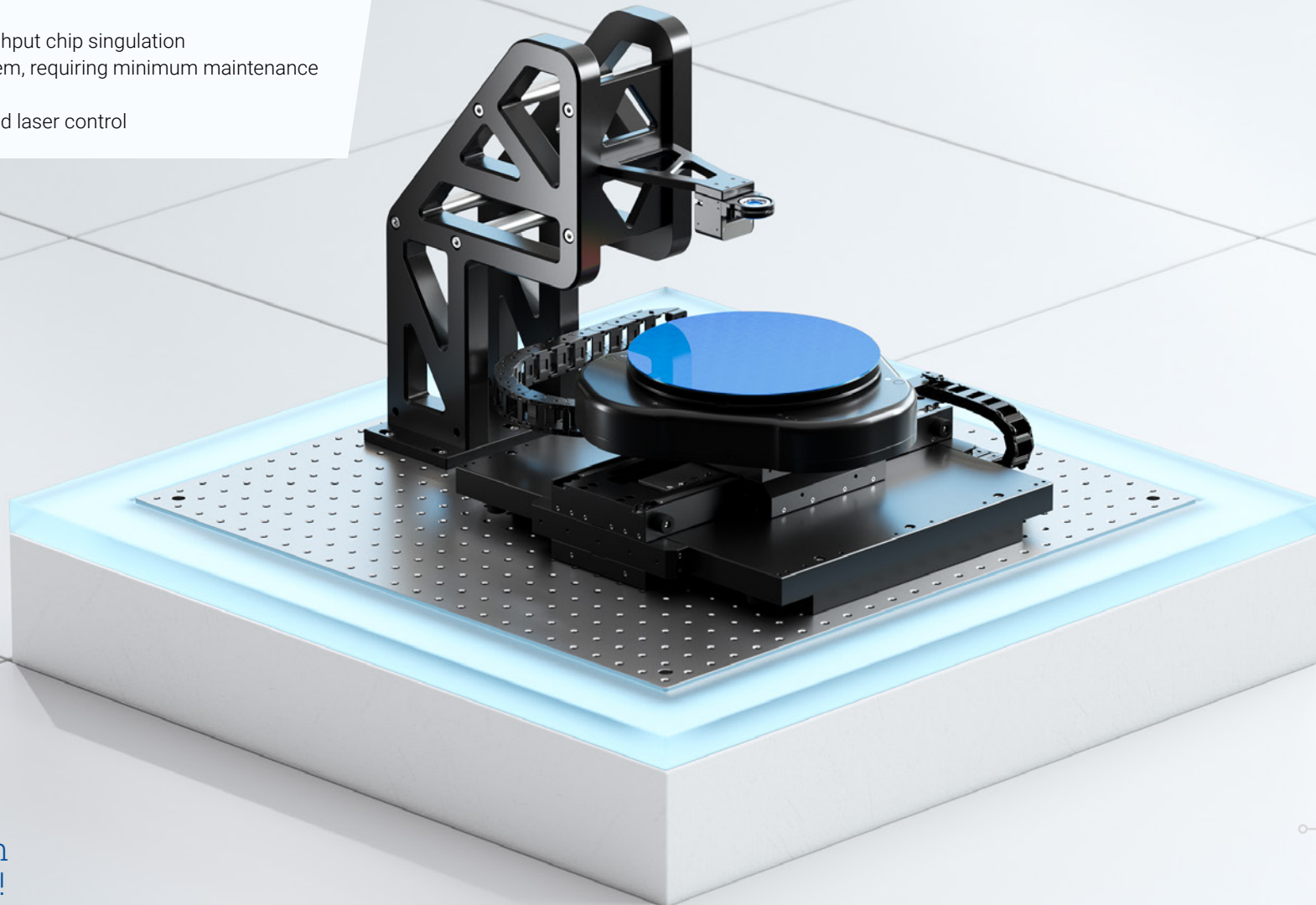

Learn
more!

In the production of (micro)chips, it is necessary to separate the individual dies from the wafer. Stealth laser dicing involves creating a modified layer within the wafer by focusing a laser below the surface, then using a tape expander to separate the chips. Typical challenges faced are contamination risks to the wafer, accurately positioning the modified layer onto both XY axes to enable the narrowest possible streets, and maintaining the focus within the wafer and track wafer distortions. At the same time, the highest possible scanning speed is necessary to ensure high throughput. As requirements continue to increase, stealth laser dicing is becoming the first choice for high-volume, MEMS dicing, or smaller and more complex dies. PI responds to the demands of laser-dicing processes with motion systems offering both high accuracy and a high level of straightness at high velocities.

Z Axis: High-Dynamic Laser Focus Control

- Wear-free, lever-amplified piezo drives for 24/7 operations without particle generation
- Mechanical design with high stiffness and high resonant frequencies for high dynamics and short settling times and for high payload of larger objectives
- Up to 800 µm travel range to match the wafer thickness
- Fine positioning with subnanometer resolution

>> **P-725 PIFOC® Objective Scanner**

θX/θY/Z Axis: High-Precision Wafer Alignment and Positioning

- Parallel-kinematic design for wafer adjustment and offset corrections in three dimensions
- Direct drive linear motor with air bearings for high-precision levelling
- Frictionless design with minimal hysteresis provides high repeatability and adjustments in the nanometer range
- Low-profile design for easy integration
- Maintenance-free with long lifetime in 24/7 operations

>> **A-523 Z Tip/Tilt Stage**

XY Axis: High-Dynamic Wafer Scanning Motion

- Air bearing planar system featuring ironless linear motors for fast step-and-settle
- No wear, no tear design ideal for 24/7 high duty cycle operation
- Minimal runout errors and nanometer straightness and flatness
- Low profile, monolithic design allows easy integration to system level solutions

>> **A-311 Air Bearing Planar Scanner**

Advanced Automation Control

- EtherCAT® motion control and drive modules provide open network connectivity
>> **Controller & Drives**
- Laser control module enables accurate synchronized trigger of laser based on motion profile
>> **Laser Control Interface**
- Advanced algorithms like ServoBoost™ provide fast step-and-settle and exceptional constant scanning velocity
>> **ServoBoost™**
- NanoPWM™ drive technology optimizes velocity and enables accurate tracking
>> **NanoPWM™ Drives**
- Integrated piezo axes deliver synchronized height control
>> **Motion Controller**



INDUSTRIAL AUTOMATION

Motion Solutions for Efficient Production Processes

Efficient Setup and Process Integration

Preconfigured Multi-Axis Systems for Industrial Applications

Key Benefits

- Flexible building kit based on proven components
- Choice of components to suit application requirements
- Preconfigured with cable management
- Scope of delivery includes adjustment, calibration, and test reports

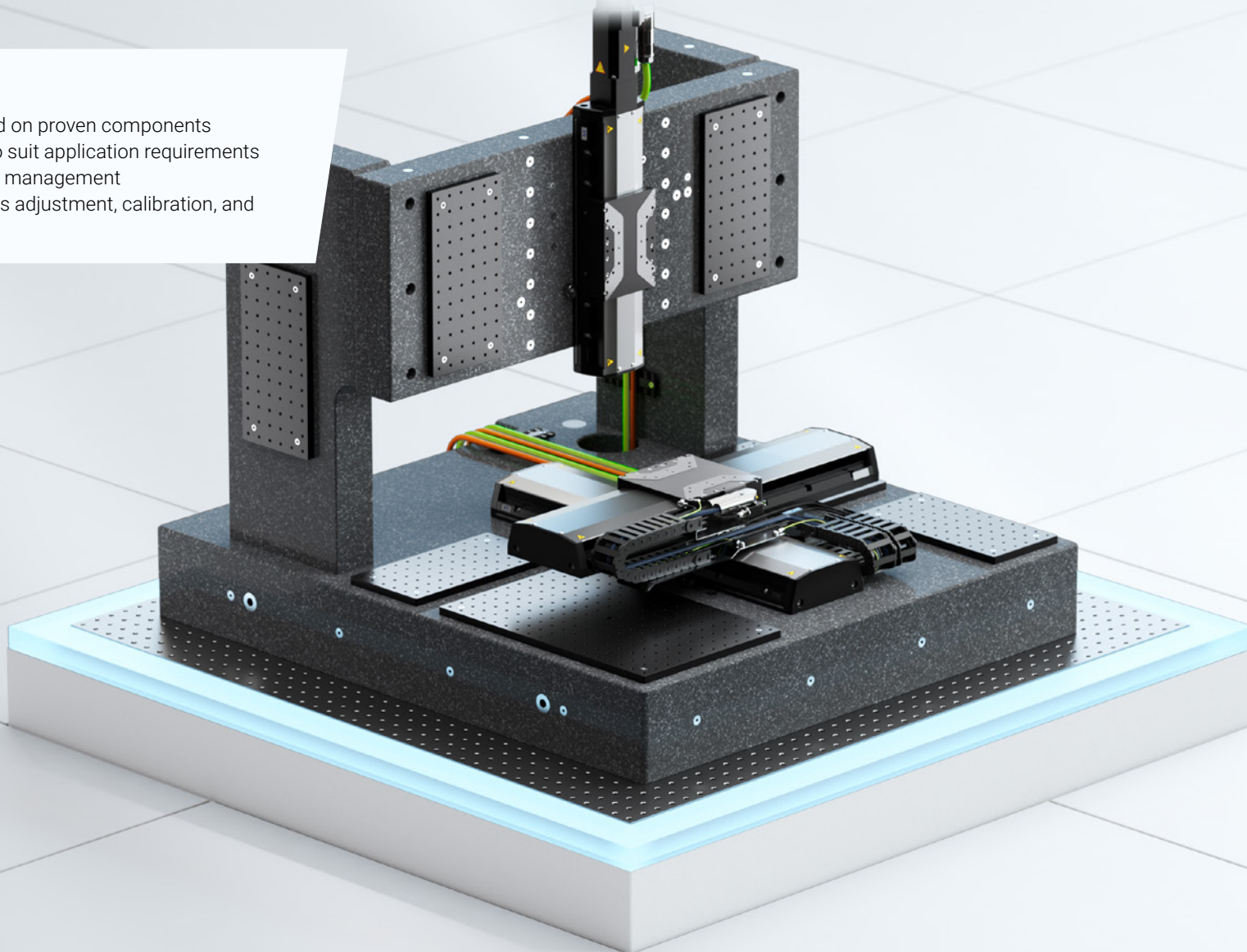

Learn
more!

Reducing design and development time is a decisive competitive factor in precision automation. This is why companies striving for optimum performance in areas such as laser material processing or metrology should rely on a powerful, well-configured system. PI supports this approach with the configurable Integrated Multi-Axis System (IMAS). The globally proven, modularly configurable system is based on a standardized, integrated approach for different expansion stages and comes configured and fully tuned including controls. The choice of several performance classes makes the system suitable for numerous applications and budget requirements. All this enables PI to offer a reliably available solution for efficiently setting up and successfully integrating new processes.

XY Axis: Workpiece Positioning

- Choice between high-load XY linear stages with various travel ranges from 102 mm to 407 mm
- XY drag chain cable management for smooth integration
- Stage tuning for selectable payloads
- Metrology options: XY orthogonality to 35 to 20 μ rad, axis mapping, 2D mapping
- High dynamic motors in various performance classes
- Connector for purge air, side seal, and hard cover to protect against particles

>> **X-417 Integrated Multi-Axis System**

Motion Control

- ACS EtherCAT® network motion control
 - >> **G-901 Motion Controller in three versions**
- Synchronization of motion to laser/event for high accuracy cutting at high speeds
 - >> **PEG / Laser Control Module***
- Servo control for improved tracking at higher duty cycles and for disturbance rejection
 - >> **ServoBoost™***
- Support of higher-level languages: C, C#, .Net, LabView™, MATLAB®, Visual Basic®, Python

*Optional add-ons

Z Axis: Adjustment

- High-load linear stage with holding brake
- Various travel ranges from 102 mm to 204 mm
- Available as a folded version for a reduced installation space in Z axis
- Optional mounting of the Z axis directly on the XY stage or to a fixed structure, travel range 26 mm
- A supplementary rotary stage will be available in the future
- Robust industrial IP65 connectors for flexible cable exit

>> **X-417 Integrated Multi-Axis System**

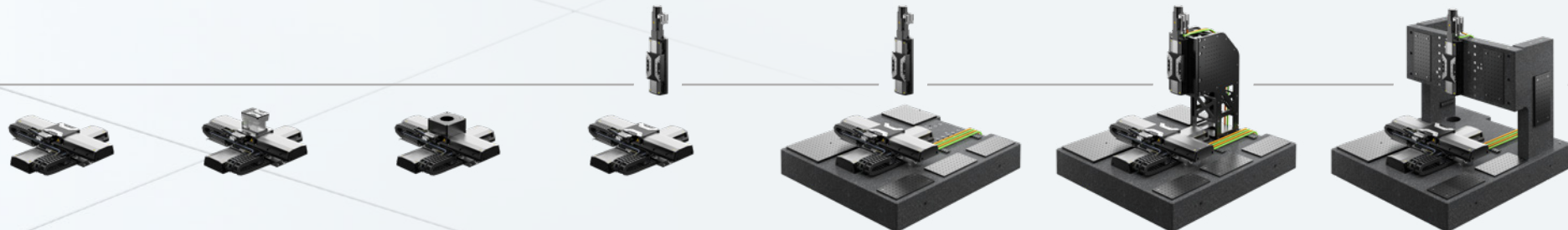

Scalable Standard Levels of Integration with Flexible Travel Ranges, Payloads, Mounting Options and Optional Accessories

3D Profiling of Small Components and Features

Gantry Solutions for Fast and Reliable Sensor Placement and Scanning

Key Features

- Compact and economic design
- Highly repeatable motion path
- Extremely small measurement spot size
- High sensor bandwidth and resolution for fast responsiveness
- Increased throughput thanks to step-and-scan algorithm

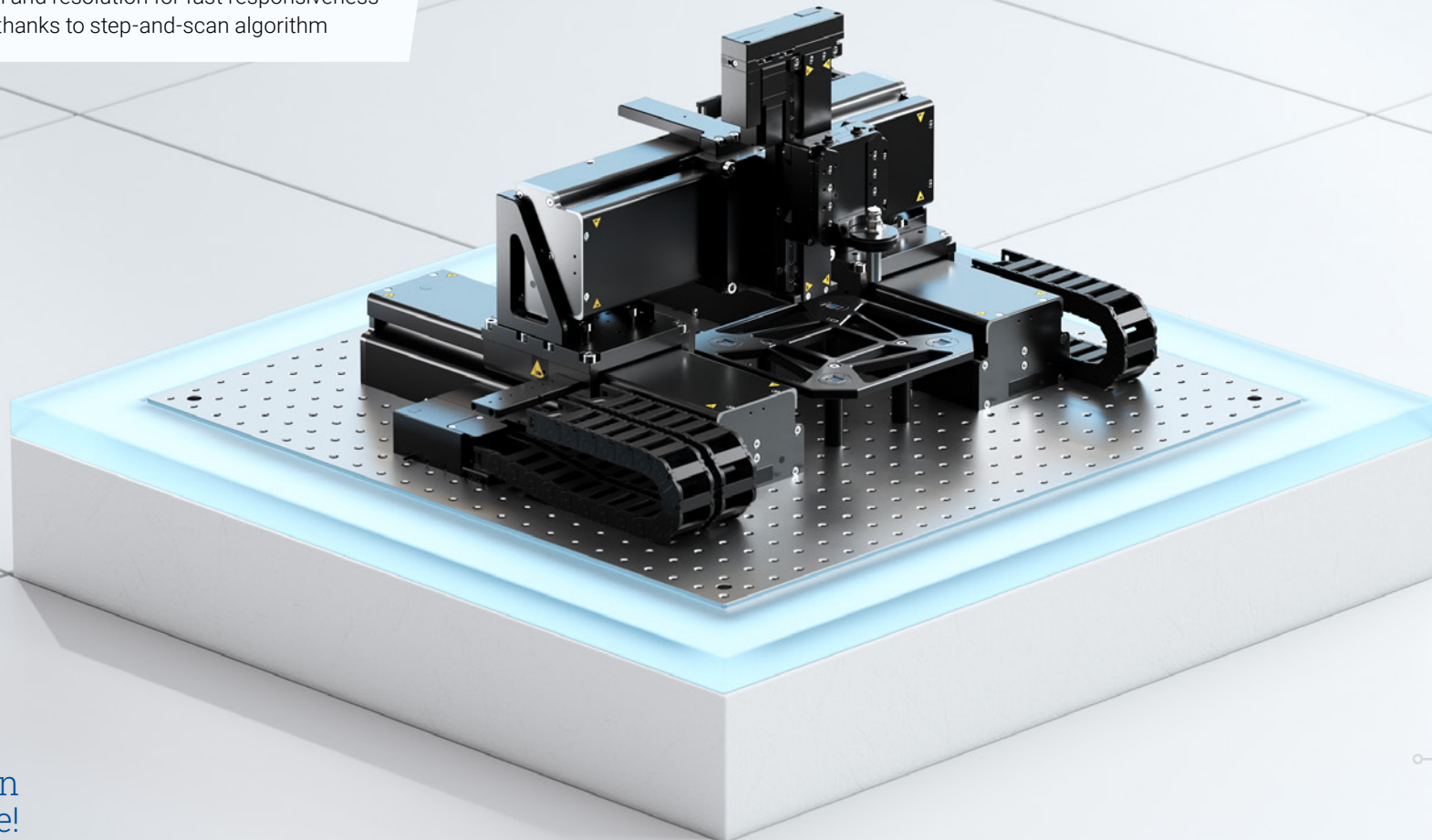

Learn
more!

Fast and reliable measurement of the surface profile of smallest components and features places high demands on the motion and control systems as well as on the sensor technology: End products must meet the requirements regarding functionality and quality. The sensor technology used should be chosen based on criteria such as sensor resolution, measuring range, and speed of data acquisition. In case of a laser-based sensor, the size of the focal spot, measurement field, or view area and the ability to focus must also be considered. The motion control system has to be configured in a way that the sensor can be placed quickly and accurately at the point or in the areas of interest. This requires either fast movement to the position with a short settling time or fast, uniform scanning of a specific area.

XY Axis: Fast Step-and-Scan Motion of the Sensor

- Ironless linear motors for high-dynamic, precise and smooth motion for fast step-and-scan
- Absolute encoders avoid referencing and ensure operational safety
- XY drag chain cable management maintains cable integrity and prolongs lifetime

>> **V-855 High-Speed Linear Stage**

Z Axis: Sensor Focusing for Distance Control

- Voice coil direct drive motor for friction-free operation, high scan frequencies and fast step-and-settle
- High-resolution linear encoders for accurate position feedback
- Adjustable weight force compensation for safe operation
- Easy integration thanks to flexible mounting options

>> **V-308 Voice Coil PIFOC® Focus Drive**

Advanced Automation Control

- EtherCAT® motion control and drive modules provide open network connectivity
- Conversion of sensor output to position data for fast output via analogue or digital interfaces
- Extensive motion controller algorithms for fast move-and-settle, as well as smooth scanning
- Autofocus capabilities for dynamic focus adjustment

>> **Motion Controller**

Z Axis: Precise Vertical Motion of the Sensor

- High-precision ball screw linear stage with stepper motor and holding brake for reliable operation with simple and extremely stable positioning
- Folded drivetrain and compact design reduces installation space
- Low-weight design to maintain gantry dynamics

>> **L-836 Stackable and Highly Compact Linear Stage**

Measuring Surface Depths

- Spot size down to 2 µm for the measurement of tiny features, as well as for extremely precise positioning
- Wide range of working distances
- High resolution at fast speeds for dynamic autofocus compensation and high throughput



MICROSCOPY & LIFE SCIENCE

Economic Piezo-Driven Solutions for Exceptional Precision

Superresolution Microscopy

Exceptional Precision for Demanding Tasks

Key Features

- Mechanically compatible with inverted microscopes of leading manufacturers (Nikon, Olympus, Leica, Carl Zeiss)
- Compact, low-profile designs for easy access to samples
- Fine positioning stages (X / Y / Z / Θ X / Θ Y / Θ Z)
- Comprehensive accessory range
- Custom versions available for other microscopes upon request



Learn
more!

Superresolution microscopy requires precise, reliable, and reproducible sample positioning, objective alignment, and imaging system integration. With its advanced piezo-driven technology, PI's ultrasound-based microscope platform offers exceptional precision, making it the perfect choice for demanding tasks in modern microscopy. The platform is designed for a broad range of applications, including widefield and confocal fluorescence microscopy, deep tissue fluorescence imaging, multi-photon techniques, and superresolution microscopy. To optimally support all applications, the platform can be expanded with specialized components such as subnanometer resolution XYZ stages, piezo scanning Z stages, and holders for slides, Petri dishes, and microtiter plates. When combined with a piezo-controlled focus scanner, the system delivers exceptional linearity, stability, and maintenance-free operation. Additionally, its mechanical compatibility with leading manufacturers' microscopes ensures versatility, while innovative technology makes this high-precision positioning solution accessible to a broad spectrum of users.

XY Axis: Precise Sample Positioning Stage

- Exceptional stability and minimal long-term drift
- High-resolution PLine® piezo linear drives for precise motion, small minimum step size and good reproducibility
- Dual-frequency drive mode for smooth operation and minimized noise
- Automatic trajectory parameter adaptation to ensure maximum stability and reproducibility
- SW-compatible: µManager, NIKON NIS Elements, Python, Andor iQ, NI LabVIEW
- User-friendly PI software: PIMikroMove®, PI General Command Set (GCS)

>> **U-781 PLine® XY Stage System**

XY(Z) Axis: Nanometer Sample Positioning Stage

- Subnanometer resolution with millisecond response times
- Precision positioning of ±5 nm
- Low-profile construction (20 mm) for seamless integration
- Clear aperture compatible with 3x1" microscope slides; recessed, insertable holder included in scope of delivery
- Travel ranges up to 200 µm × 200 µm × 200 µm
- Exceptional durability with PICMA® piezo actuators

>> **P-545.xR8S PInano® XY(Z) Piezo System**

Accessories

- Sample holders for microscope slides, Petri dishes, and microtiter plates



Z Axis: Fine Positioning of Microscope Objectives Drive

- World-famous PIFOC series (PIFOC = PI Focus Drive)
- Mechanically compatible to standardized objective nosepiece threads
- Subnanometer precision for fine positioning of objectives
- Large clear aperture with Ø 29 mm for improved optical performance
- Faster response and longer lifespan compared to motorized drives
- Travel range options: 100 µm, 400 µm, and 800 µm

>> **P-725.xCDE1S PIFOC**

Motion Control

- Most systems include a controller, whereas some offer optional controllers with varying levels of precision
- Trajectory support for 1D or 2D motion patterns
- Integrated interfaces: USB, RS-232, TCP/IP, SPI, I/O
- Integrated power amplifier with dynamic frequency control for stable performance
- Multifunctional encoder input: A/B, sin/cos, BiSS for versatile connectivity
- Macro programmable for stand-alone operation
- Daisy chain networking support for scalable configurations

>> **Motion Controller**

Mastering Motion in Six Degrees of Freedom

Versatile Platforms for Multi-Industry Applications

PI's high precision hexapods are versatile motion platforms designed to meet the needs of a wide range of industries, including silicon photonics, semiconductor, electronics, optics, aerospace, automotive, astronomy and scientific research. With unmatched precision in six degrees of freedom, these hexapods are essential for applications such as optical alignment, robotics, industrial automation, and materials testing.

PI's latest innovations include the compact H-815 hexapod, designed for demanding industrial environments. Offering 24/7 reliability and exceptional durability, it is a robust solution for high-precision applications.

Meanwhile, the new H-811.S2IHP miniature hexapod underscores PI's leadership in innovation. Part of the world-renowned H-811 series, it offers 20 nm incremental motion, setting a new benchmark in its class.

With over 30 years of expertise, PI's hexapods combine advanced drive technologies – piezoelectric to electromagnetic – with cutting-edge sensors, software, and motion control systems to deliver tailored solutions with exceptional precision and reliability. Available in various sizes, they handle loads from 1 kg to 250 kg with repeatability up to $\pm 0.06 \mu\text{m}$, while custom versions can support over 2,000 kg. Standard hexapods operate in vacuum environments down to 10^{-6} hPa, with custom options for higher vacuum requirements.



Learn
more!

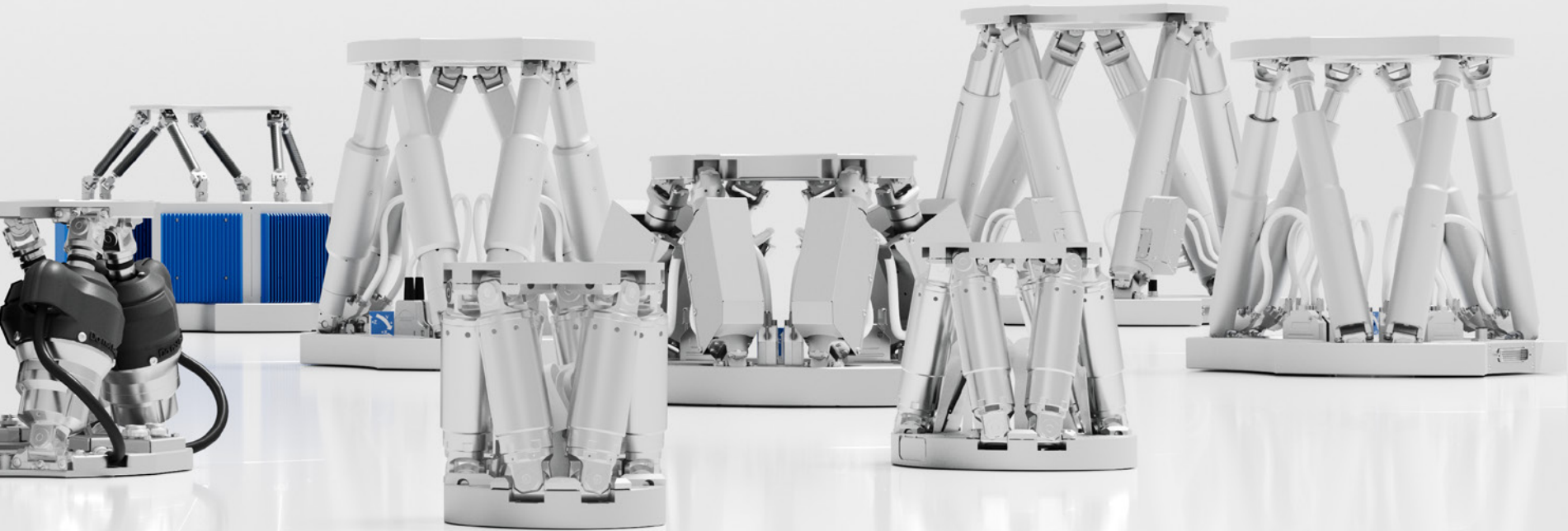

Why Choose High-Precision Hexapods from PI

Hexapods: Features at a Glance



Six Degrees of Freedom

Precision hexapods enable motion in six degrees of freedom in only one mechanical structure. The platform moves in three translational axes (X, Y, Z) and three rotational axes (θX , θY , θZ). The typical parallel-kinematic structure of hexapods consists of six variable-length actuators, each of which is connected to a base plate and a movable platform via joints.

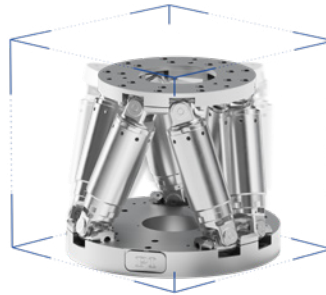

Compact Installation Space

Thanks to their parallel-kinematic design, hexapods can perform multi-axis movements, even in the most compact installation spaces. This allows them to be optimally integrated in custom processes, machines, and systems.



Freely Definable Center of Rotation

For precision hexapods, the center of rotation (pivot point) and reference coordinate system can be easily adjusted via software commands. The selectable rotation point ensures flexibility to meet specific requirements, with predefined work and tool coordinate systems being activated or deactivated as needed – no mechanical changes required.



Learn
more!

High Degree of Stiffness

Thanks to the parallel-kinematic design, hexapods are characterized by their high degree of stiffness. The performance of the hexapods is therefore not affected by external forces. They can maintain the required position even when subjected to variable forces.

Utmost Precision

Due to an exceptional design and the use of high-quality materials and components, PI's hexapods exemplify utmost precision. Standard versions achieve minimum incremental motion (MIM) to 20 nm and repeatability to $\pm 0.06 \mu\text{m}$.

Outstanding Tracking Accuracy and Dynamics



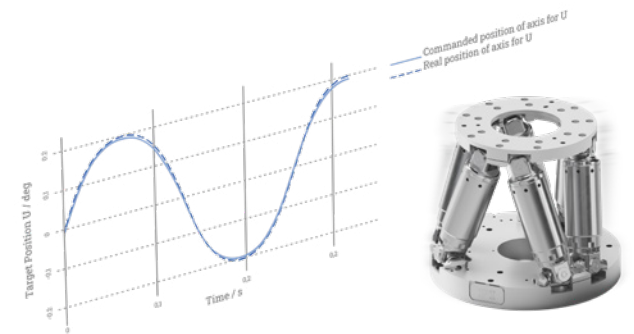
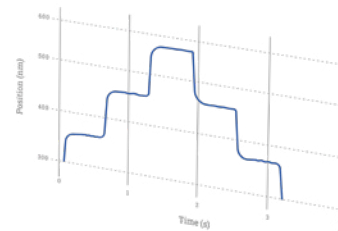

The system's high dynamics and advanced controller ensure optimal alignment between target and actual position. Trajectories for sinusoidal oscillations can be achieved with maximum tracking accuracy, while dynamic movements use low energy, as actuators only move the platform with minimal mass.



In Close Proximity to Customers and Innovation Hotspots Worldwide

Global Production and Service Networks for Regional Access to Leading High-Precision Motion Solutions

Americas

-  Auburn (USA)
-  Hopkinton (USA)
-  Nashua (USA)
-  Fremont (USA)
-  Irvine (USA)
- New from 2025**
-  Shrewsbury (USA)



National Headquarters



Sales Sites



Production Sites

















Innovation Hub / Tech Center



Service Hub

EMEA

-    PI Karlsruhe (Germany)
-  PI miCos Eschbach (Germany)
-  PI Rosenheim (Germany)
-  PI Ceramic Lederhose (Germany)
-  PI UK
-  PI France
-  PI Italy
-  miCos Iberia
-  PI Benelux
-  PI Switzerland
-  IBS
-  ACS

Asia

-    PI Singapore
-  PGW
-   PI Changzhou (China)
-   Gifu (Japan)
-  PI Japan
-  PI Shanghai (China)
-  PI Taiwan
-  PI Korea
-  PI Thailand
-  Shenzhen (China)

Global Headquarters

 Physik Instrumente (PI) SE & Co. KG
Karlsruhe (Germany)



PI

www.physikinstrumente.com

Follow us on:

